

1

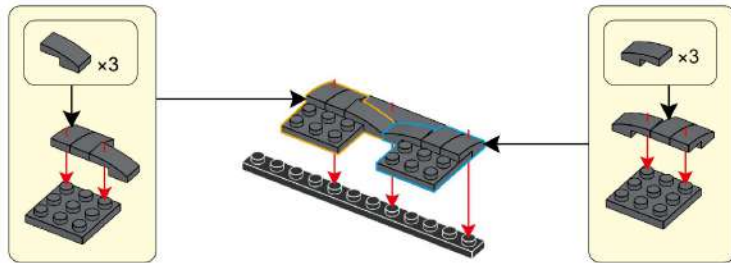

=3=

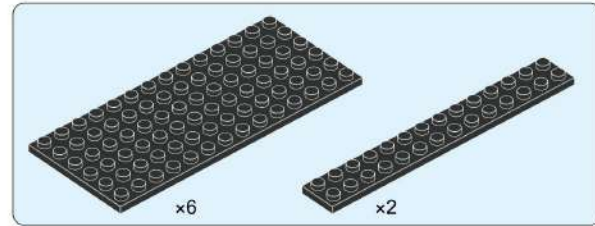

2

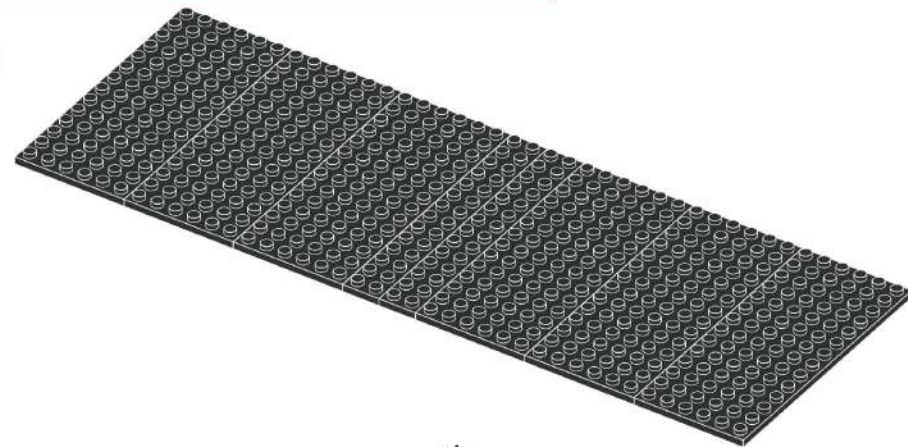

=4=

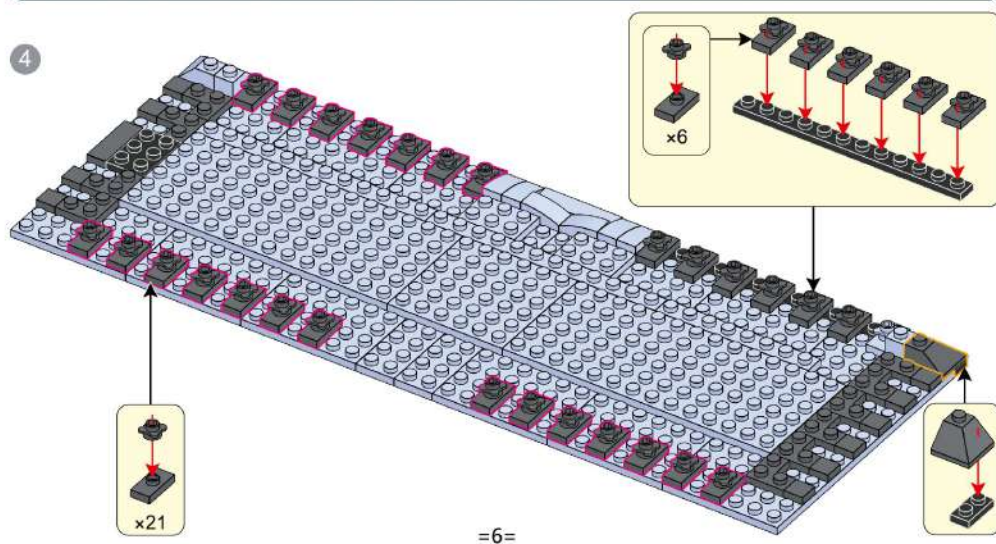
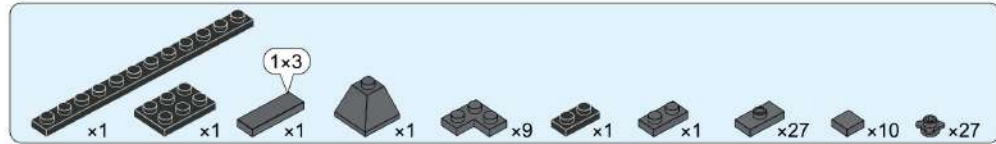
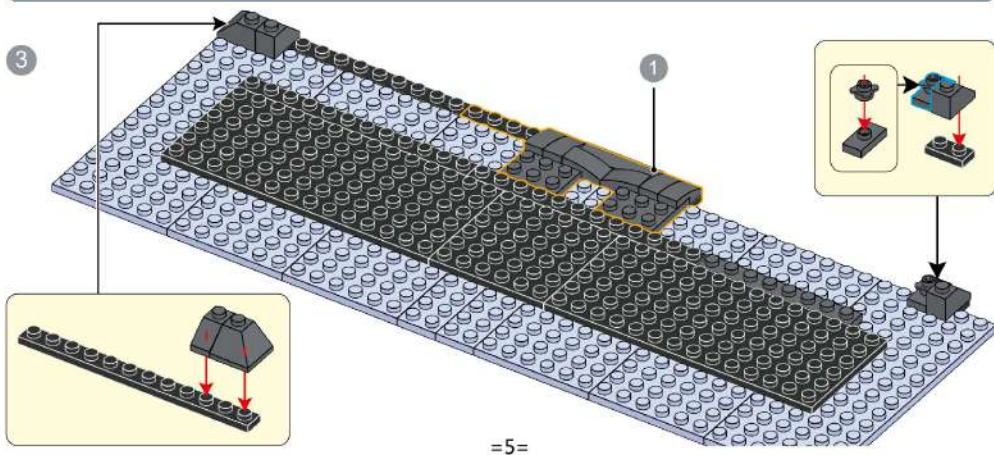
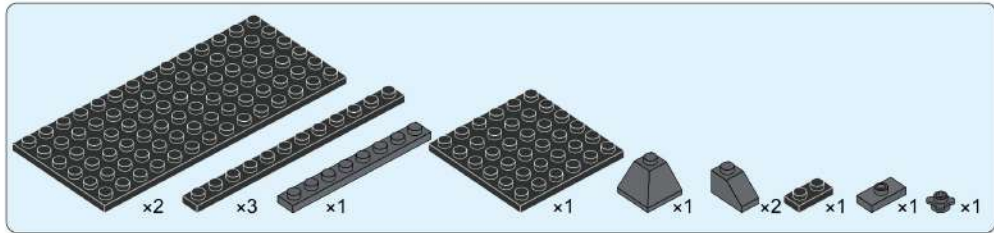

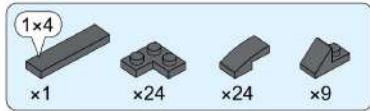

5

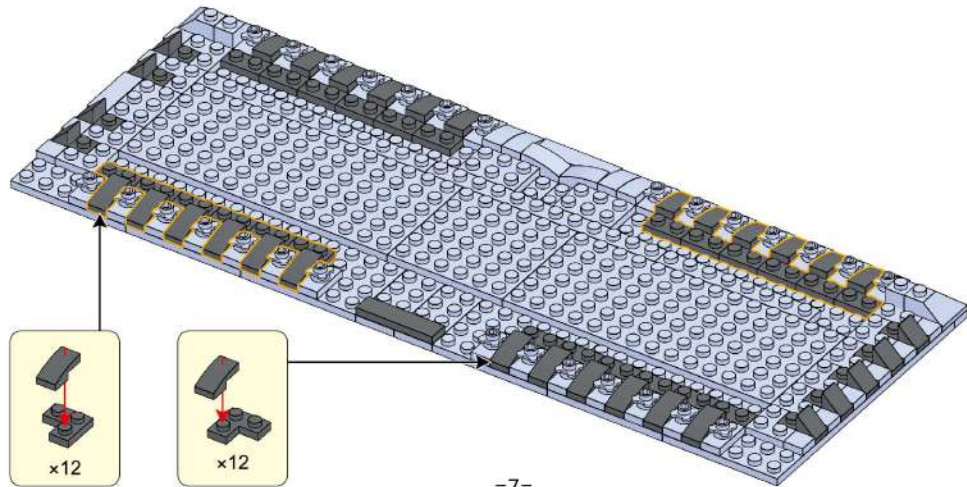

=7=

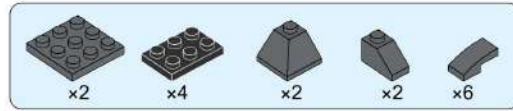

6

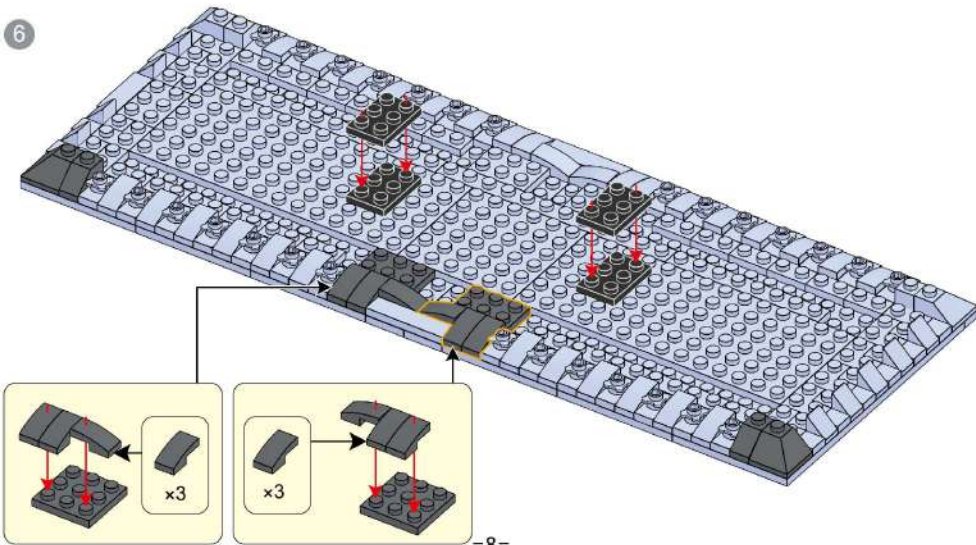

=8=

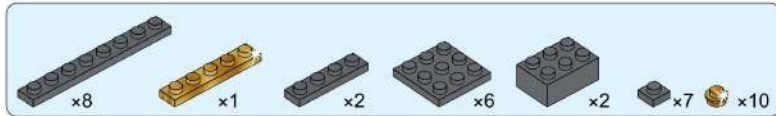

7

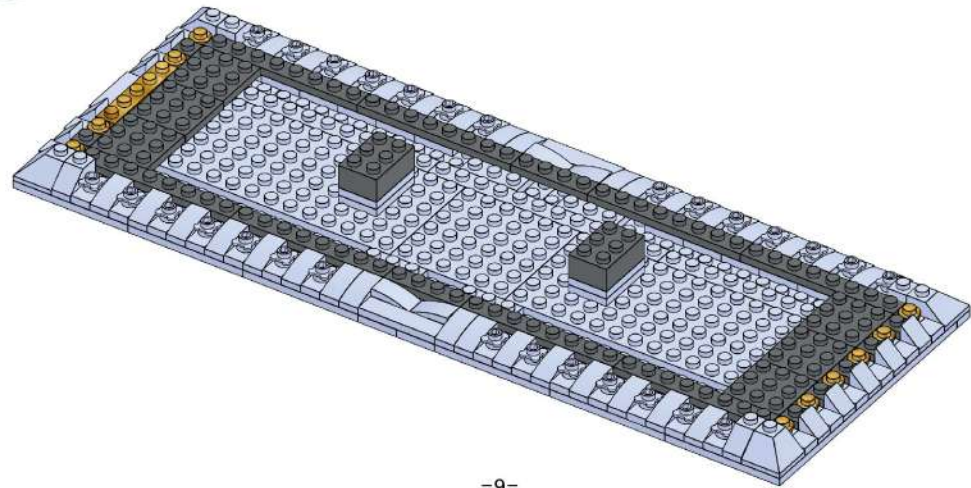

=9=

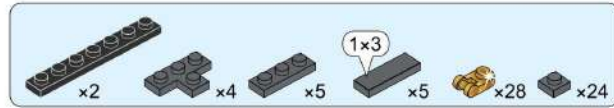

8

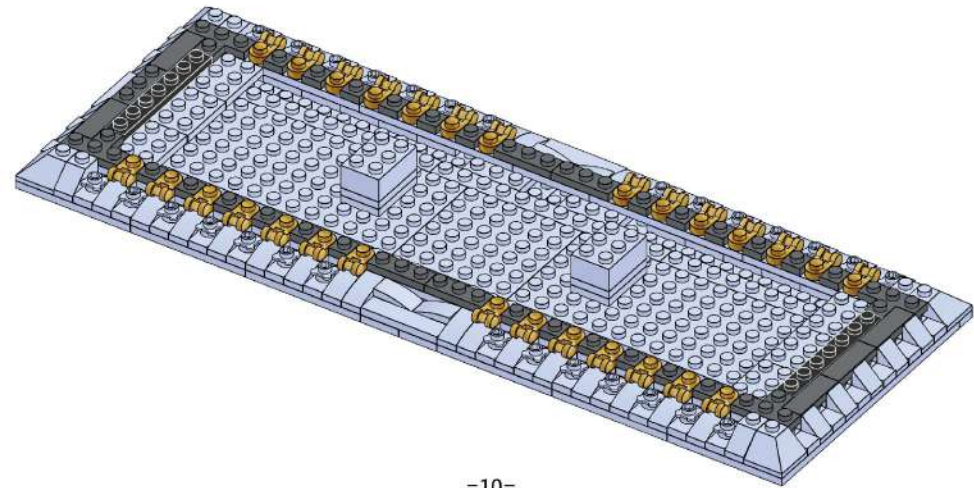

=10=

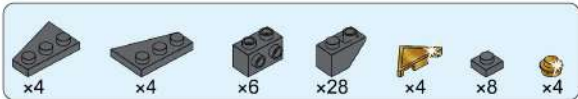

9

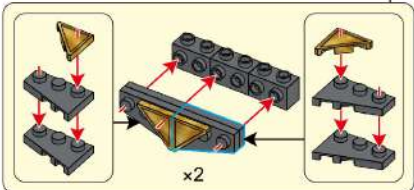
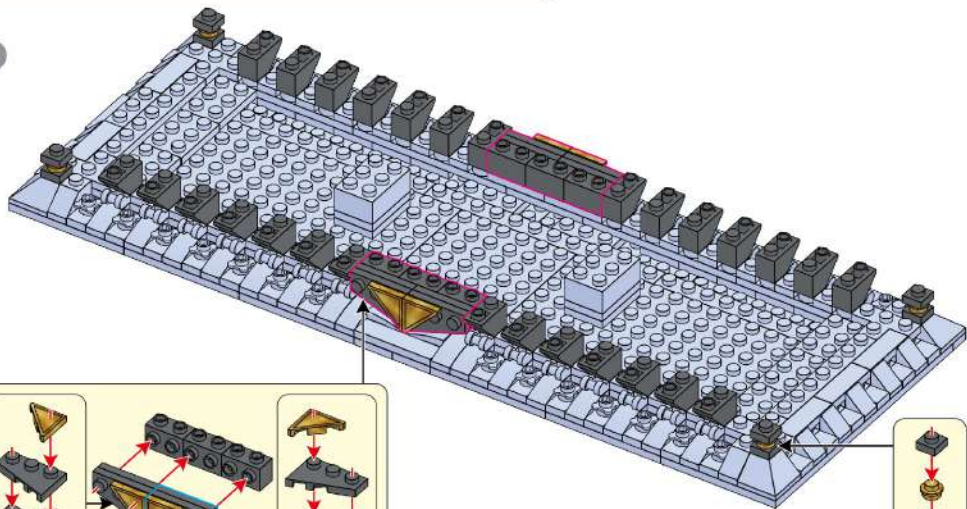

x2

=11=

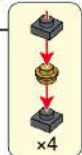

x4



10

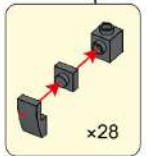
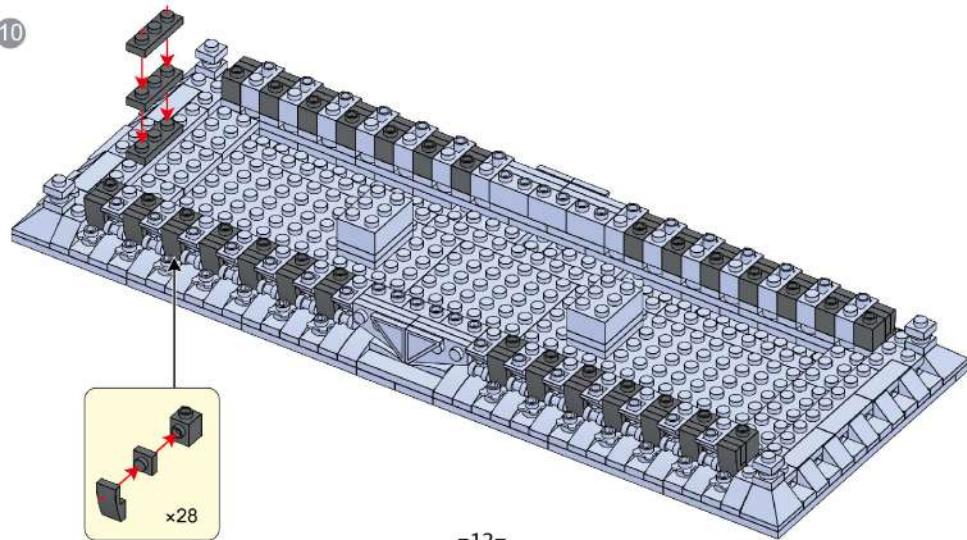

x28

=12=

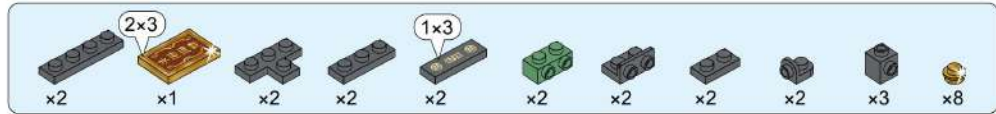

11

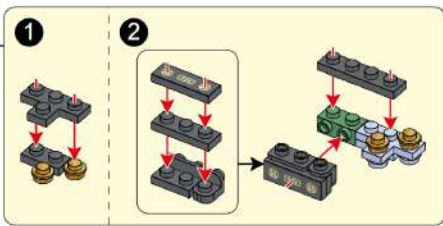
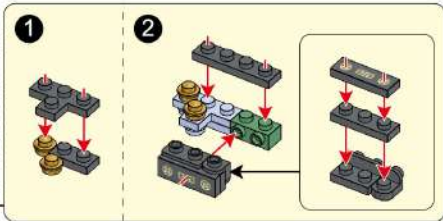

=13=

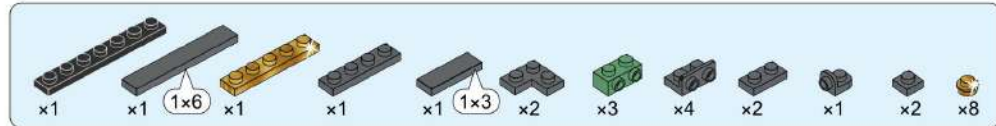

12

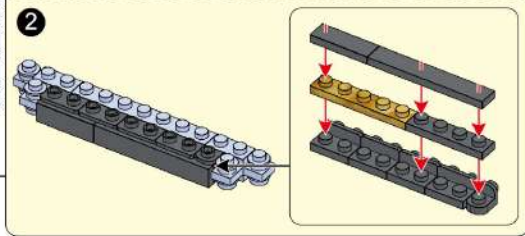
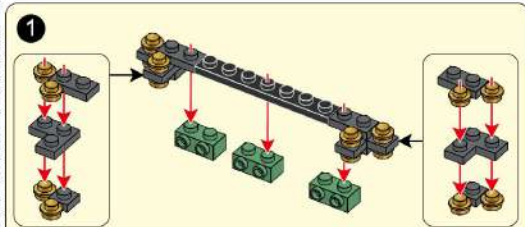
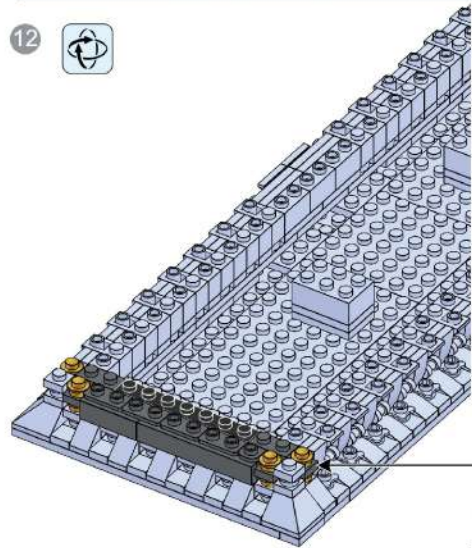

=14=

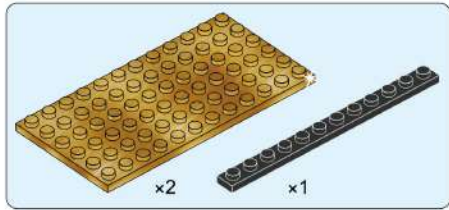

13

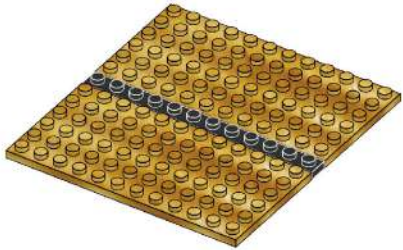

=15=

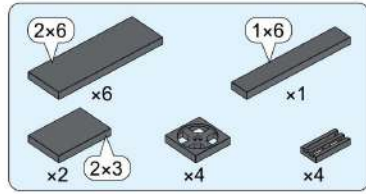

14

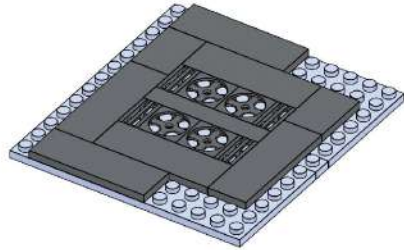

=16=

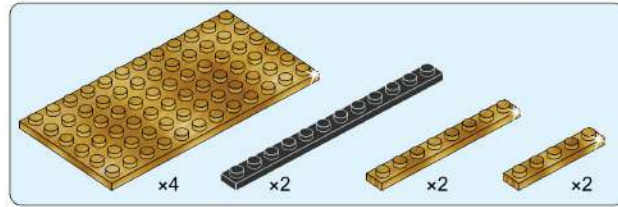

15

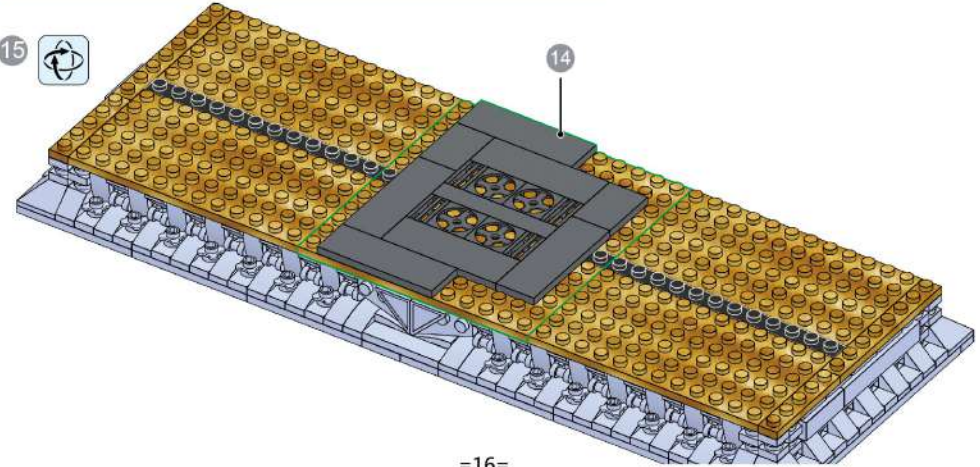

=16=



- 2x3 x12
- x3
- x6
- x5
- x2
- x1
- x4

16

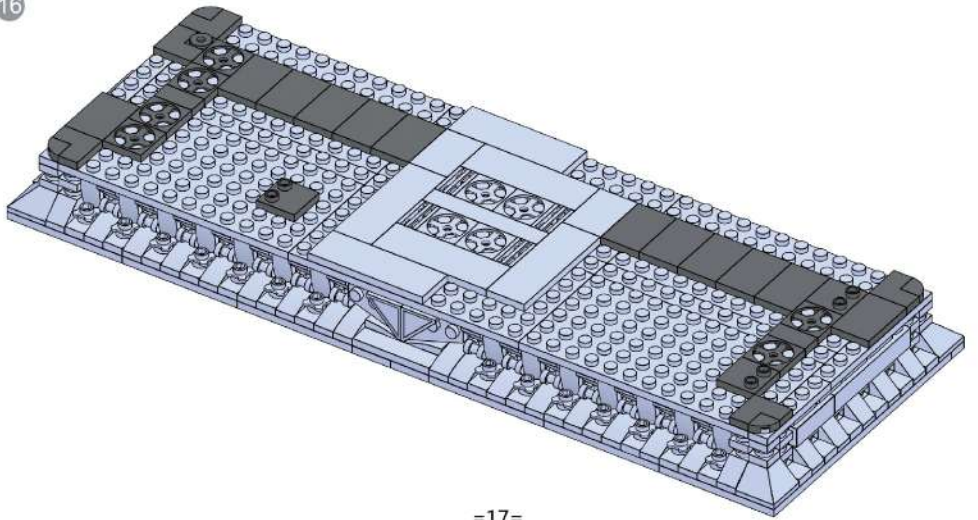

=17=

- x1
- x1
- x4
- x4
- 3 x1
- x8
- x1
- x2
- x8

17



18

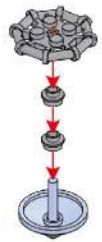

19



20

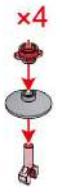

=18=

21



22



- x2
- x6
- x8
- x8

23

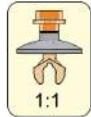

24

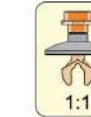

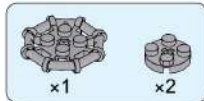

25



26

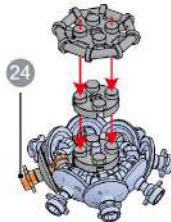

27

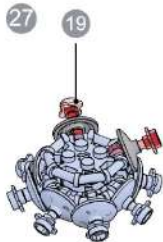

28

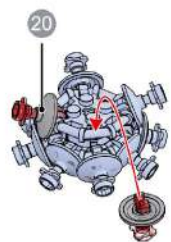

=19=



29

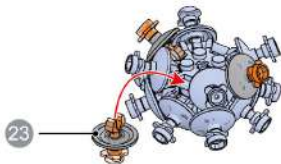

30

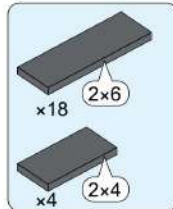
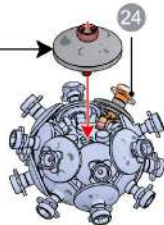
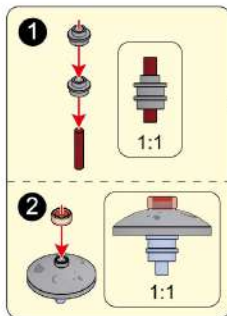

31

16

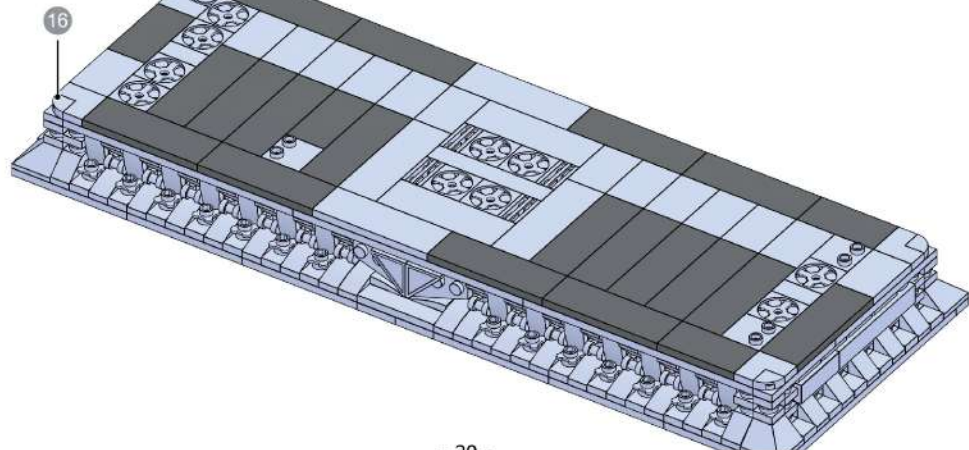

=20=

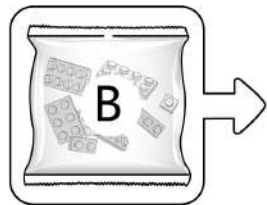

=21=

x2



x1



x2



x4



x2

50

32

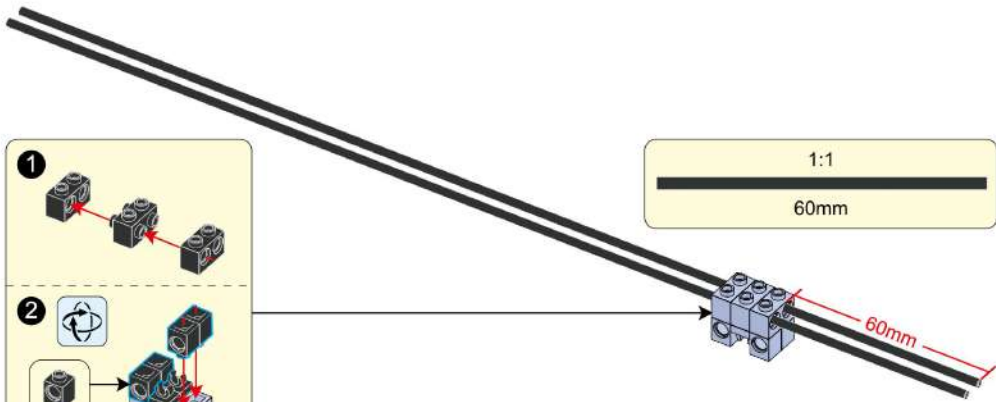

1

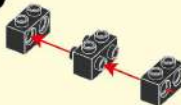

2

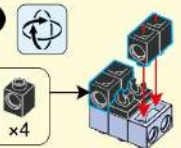

x4

=22=



33

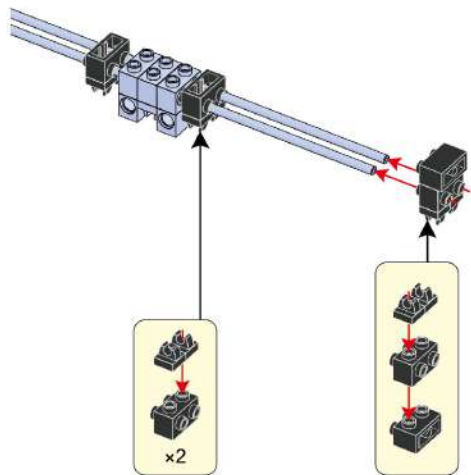

=23=



34

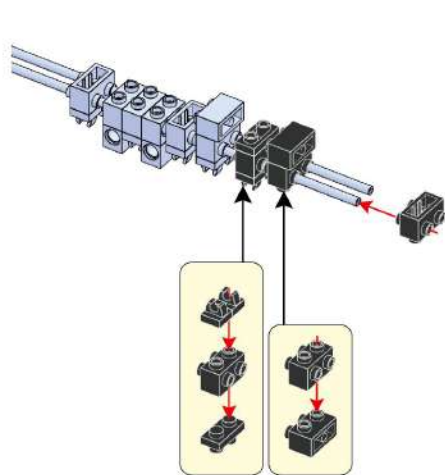

35

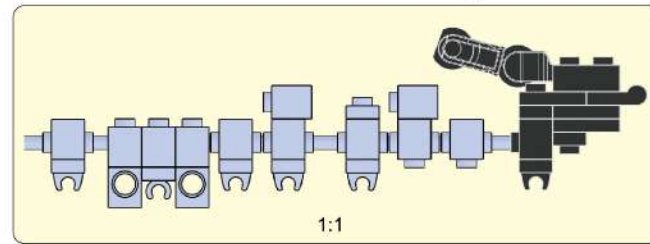
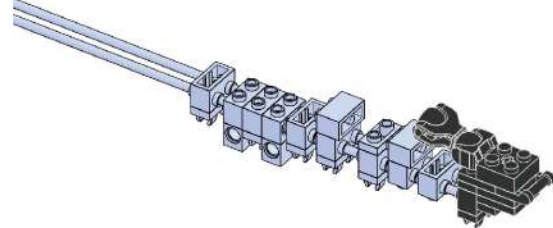

=24=

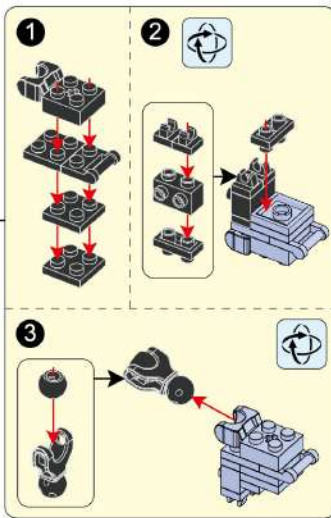



36

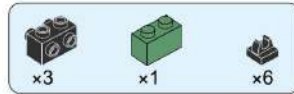
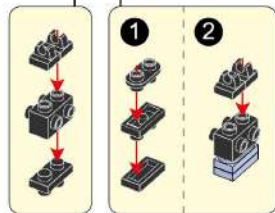
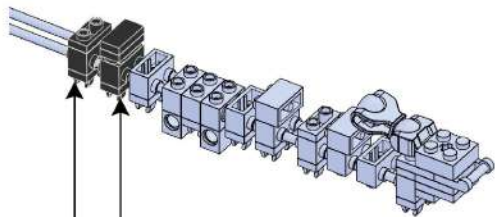

37

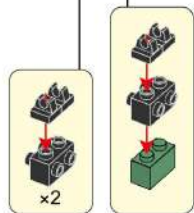
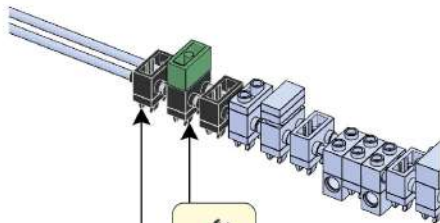

=25=

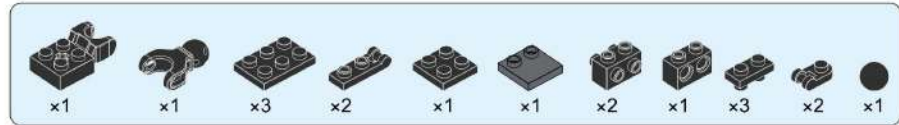

38

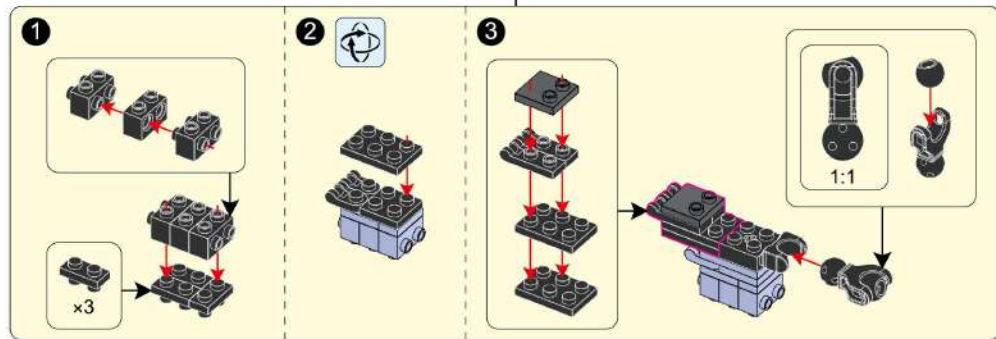
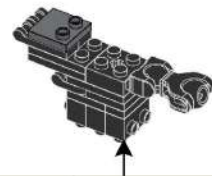

=26=

39

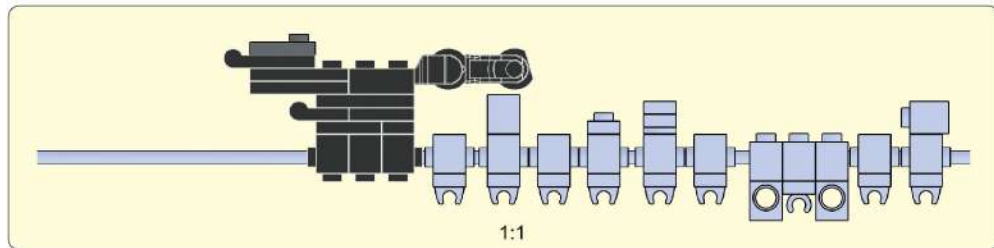
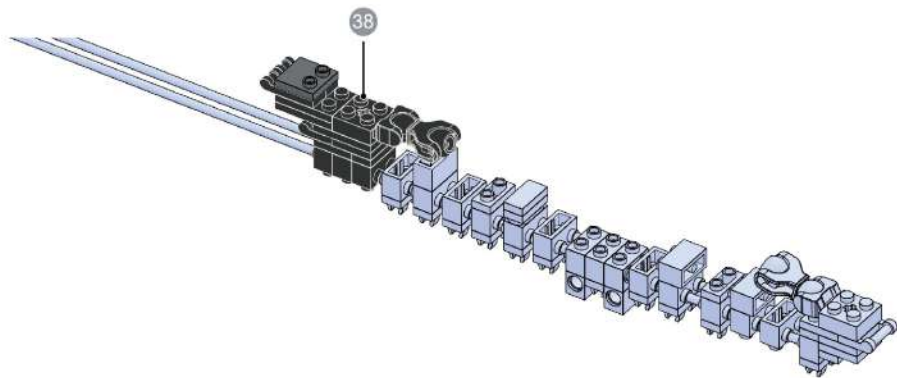

1:1

=27=

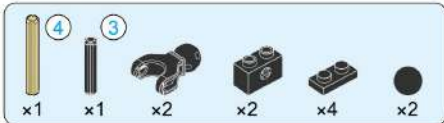

40

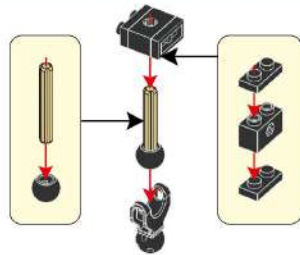

41

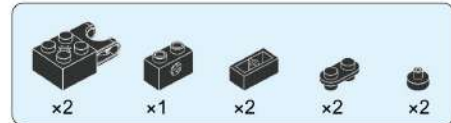
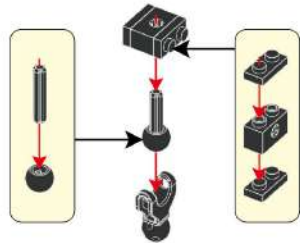

42

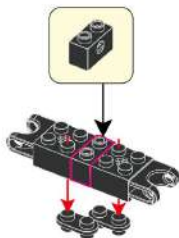

43

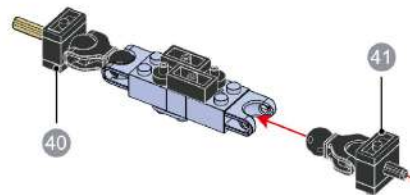

=28=

44

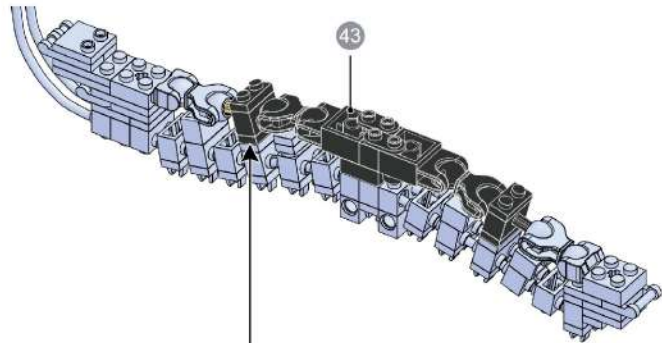

1

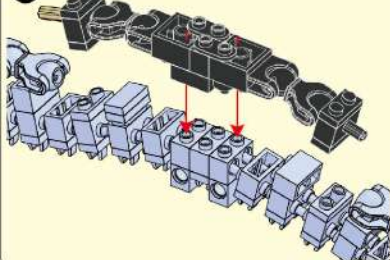

2

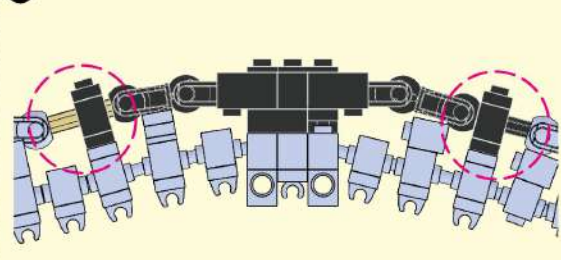

=29=

45



1

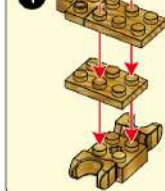

2

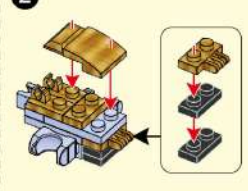

=30=

46

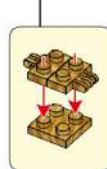
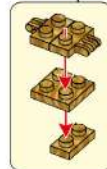

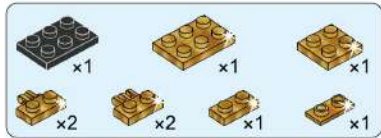

47

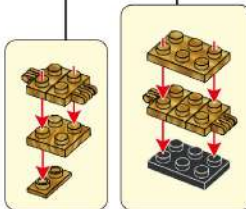
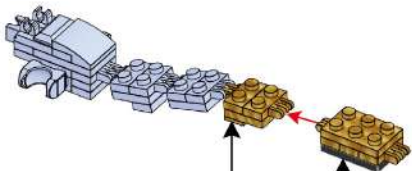

=31=



48

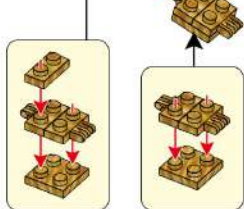
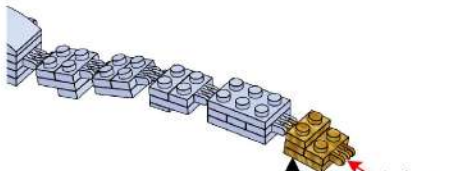

=32=



49

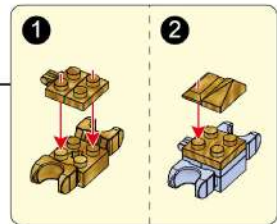
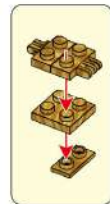
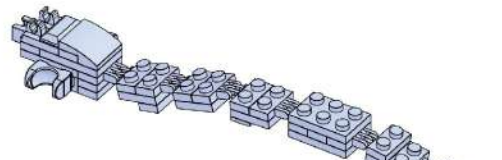

=32=





50

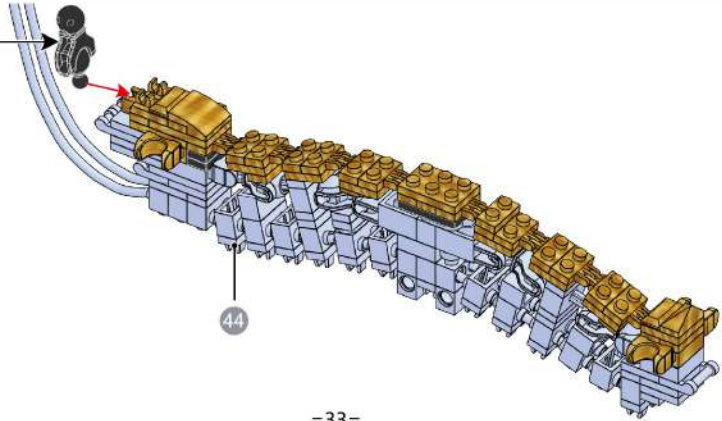
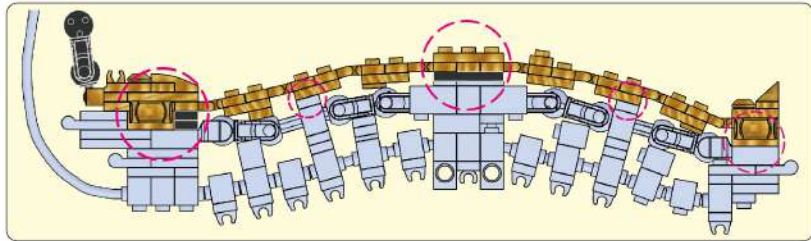
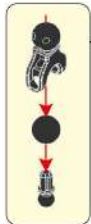

44

=33=



51

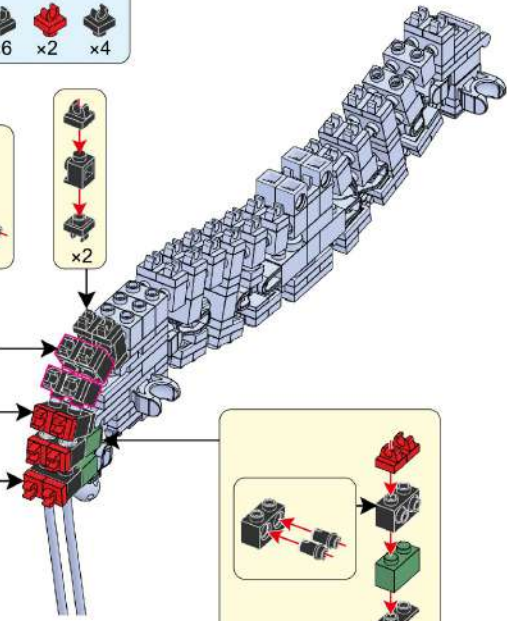
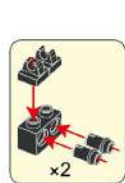
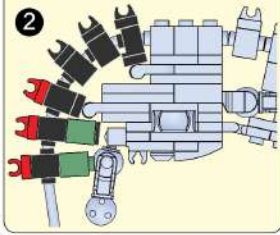
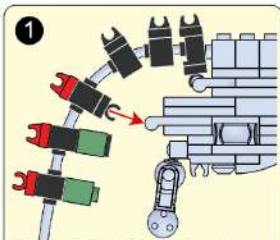

=34=

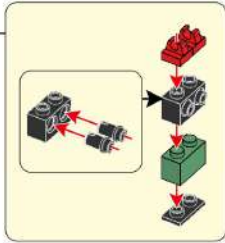



52

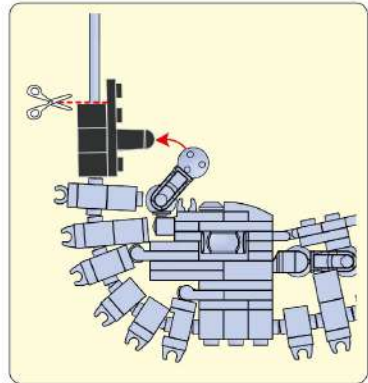
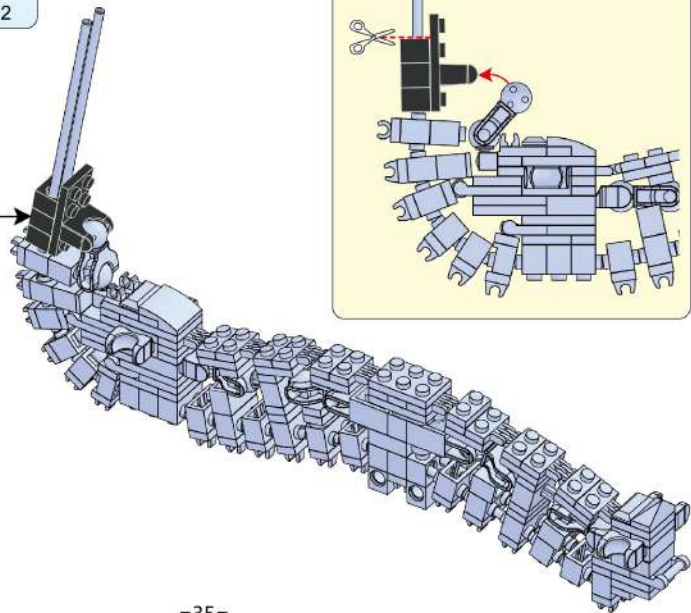
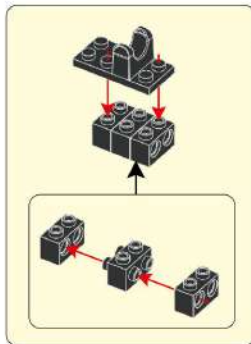

=35=

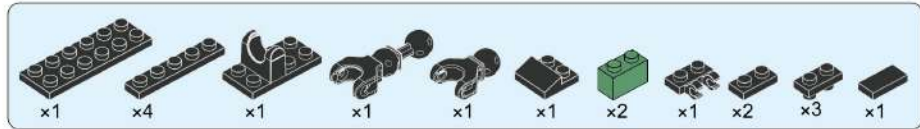

53

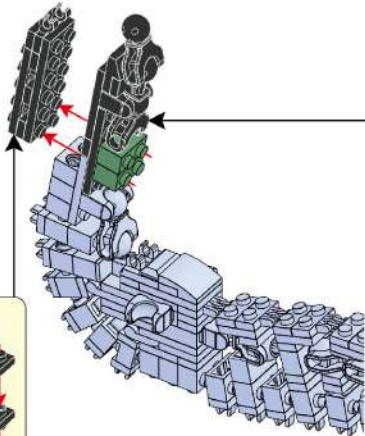
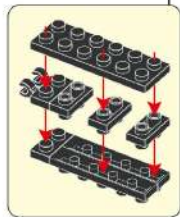

=36=

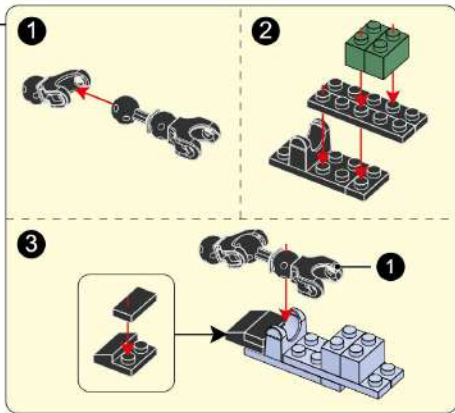

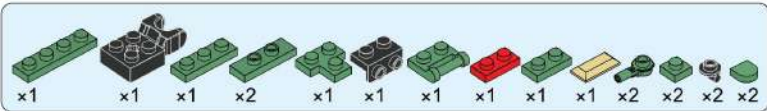

54

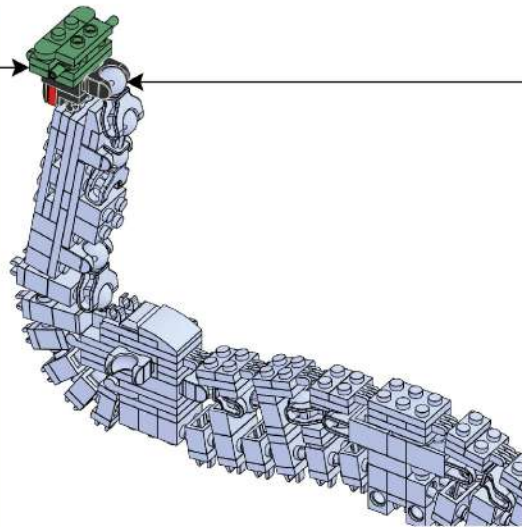
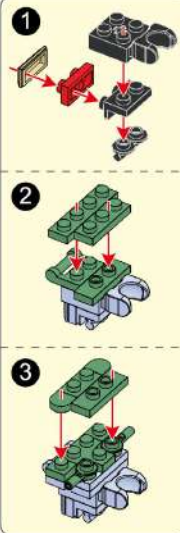

=37=

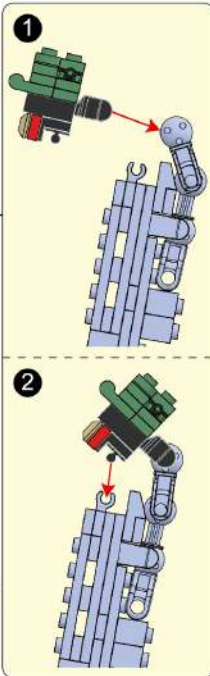

55

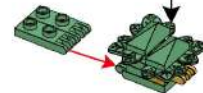
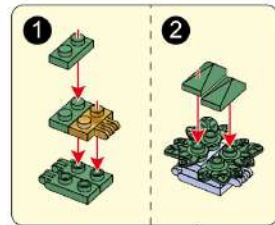

=38=



56

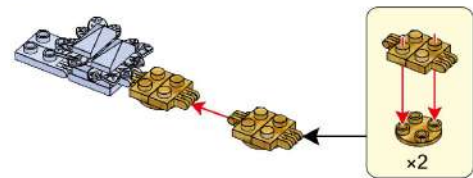

57

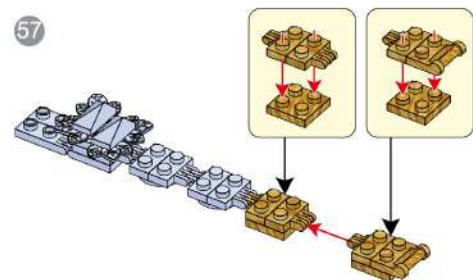

58

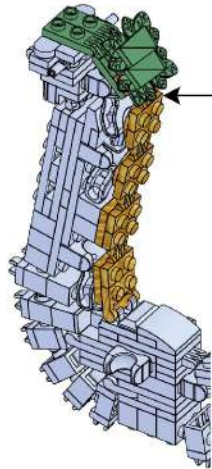

1

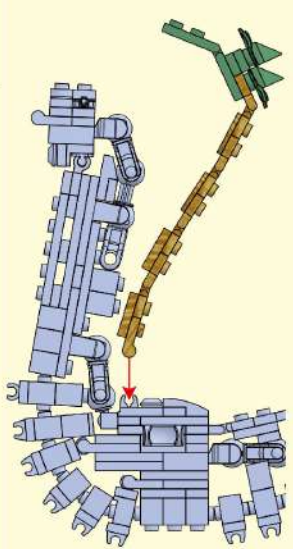

2

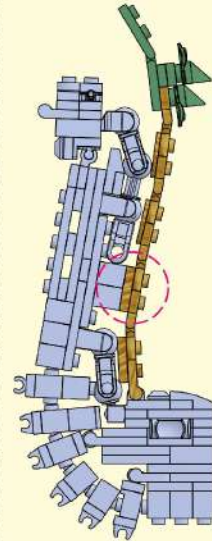

3

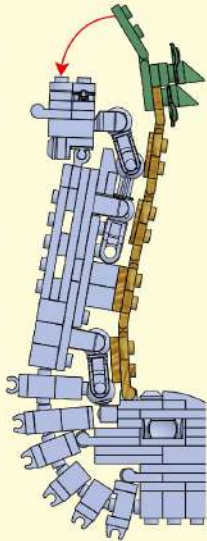

=39=

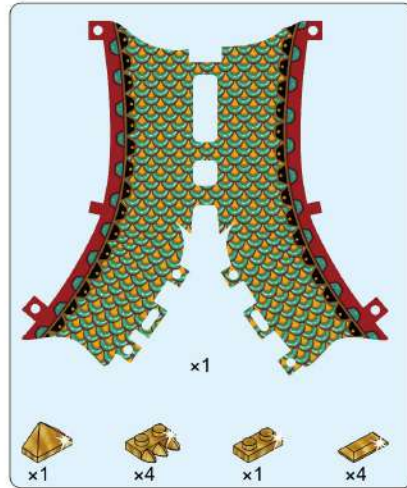

59

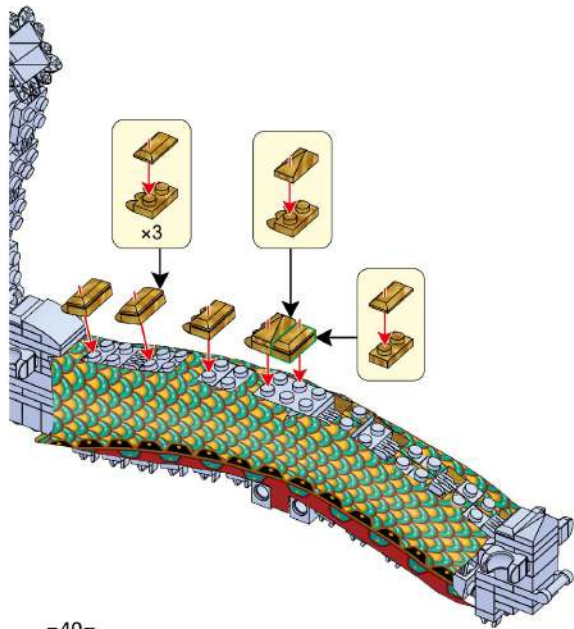

=40=



60

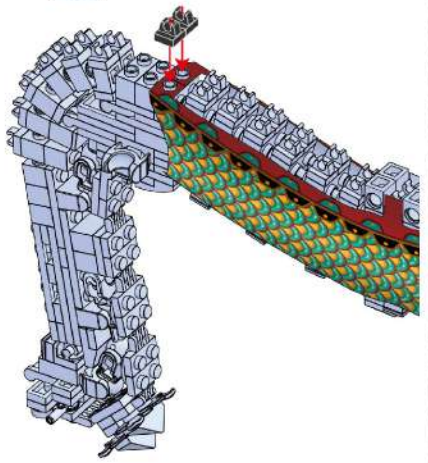

61

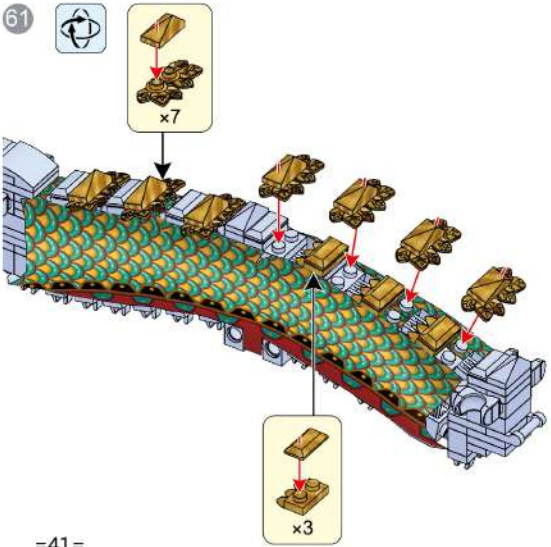

=41=



62

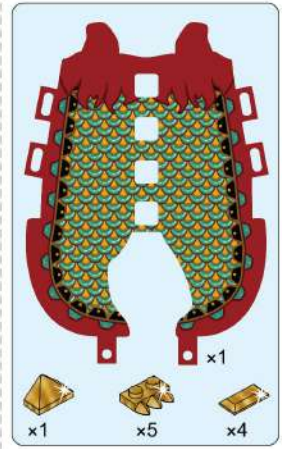
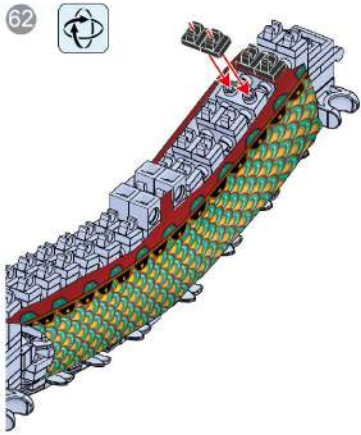

63

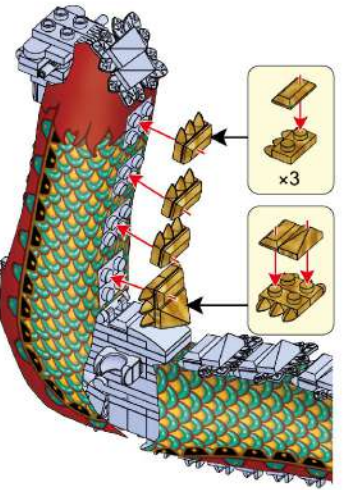

=42=



64

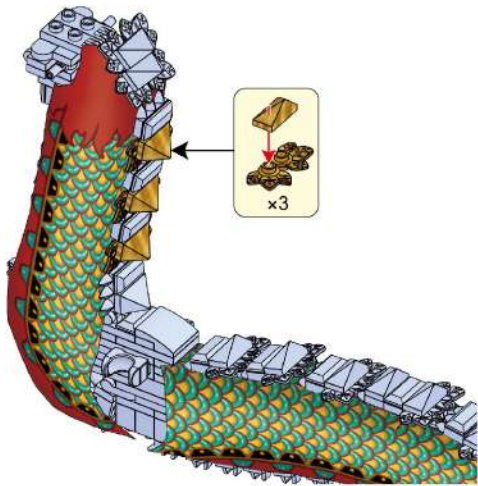

=43=



65

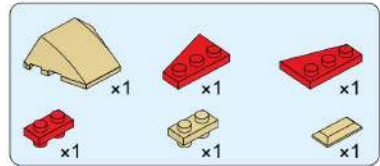
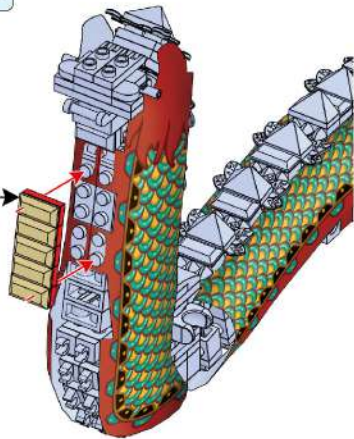
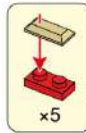

66

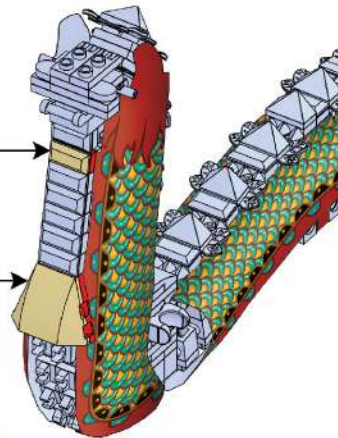
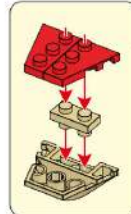
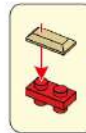

67



=44=



68

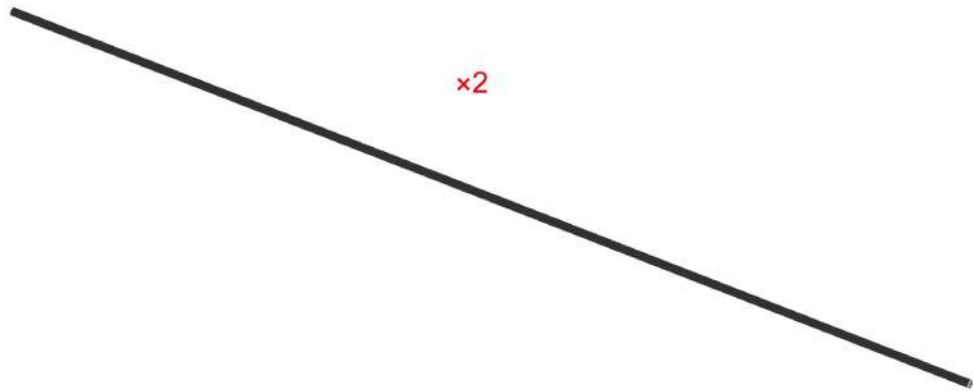

=45=



69

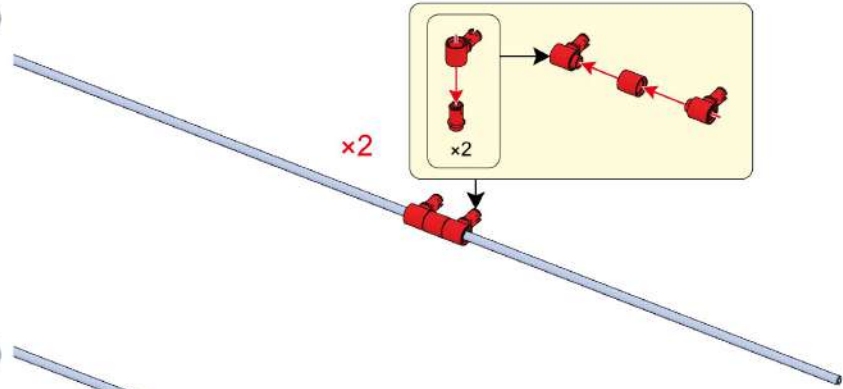

70

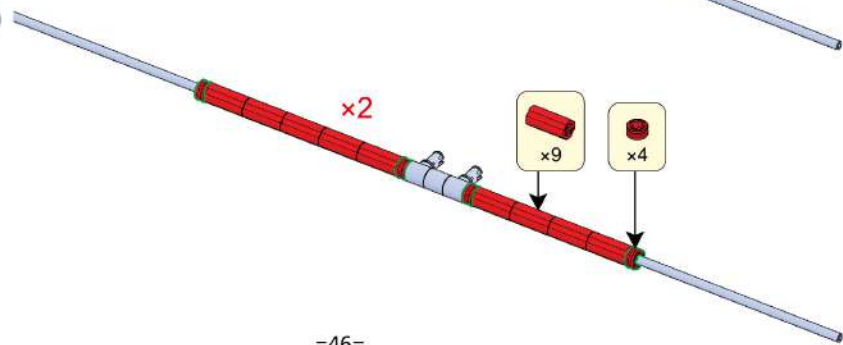

=46=



71

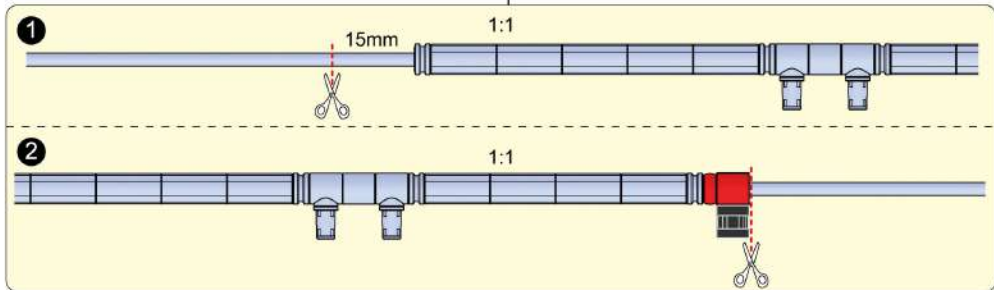
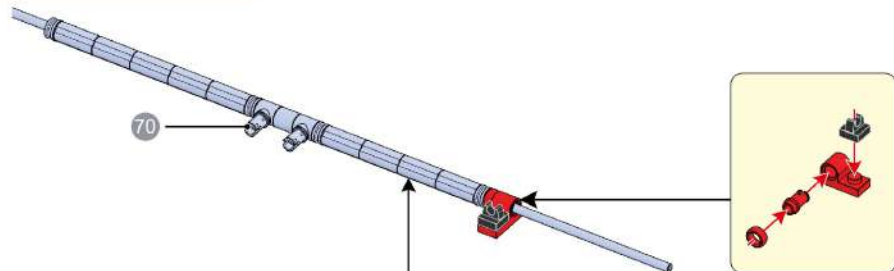

=47=



72

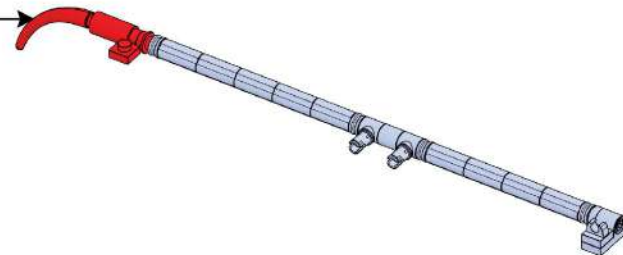
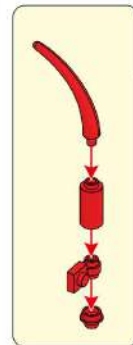

=48=





73

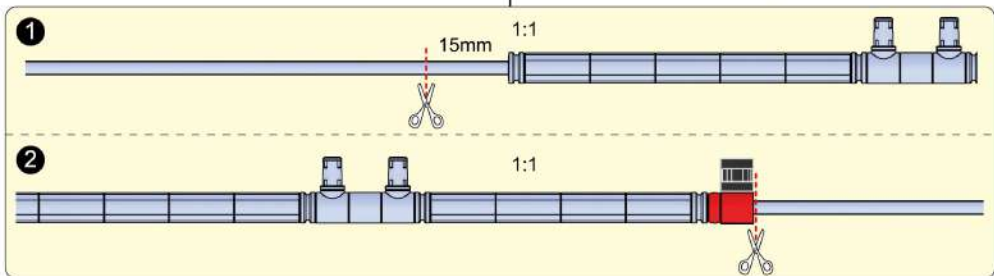
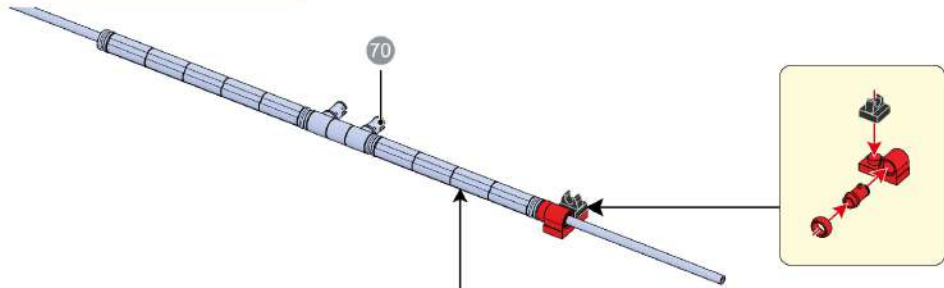

=49=

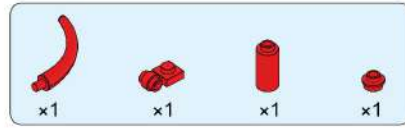

74

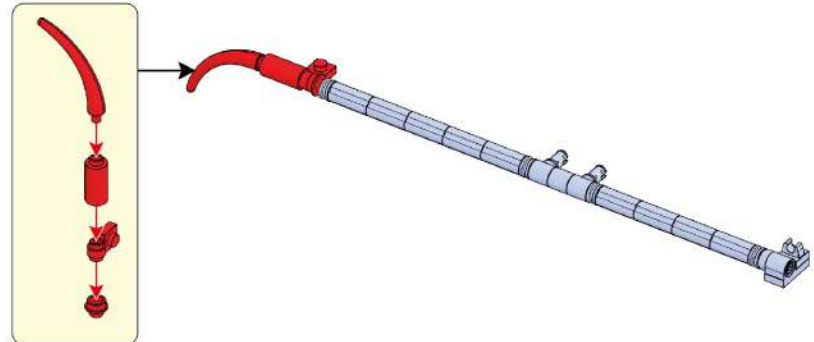

=50=

75

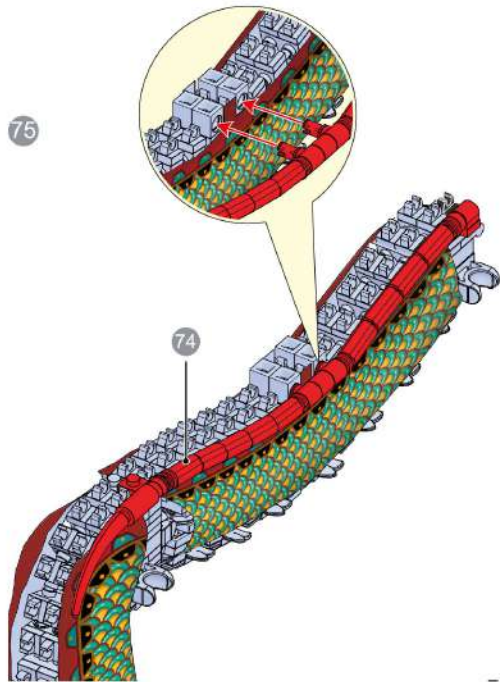

x1

76

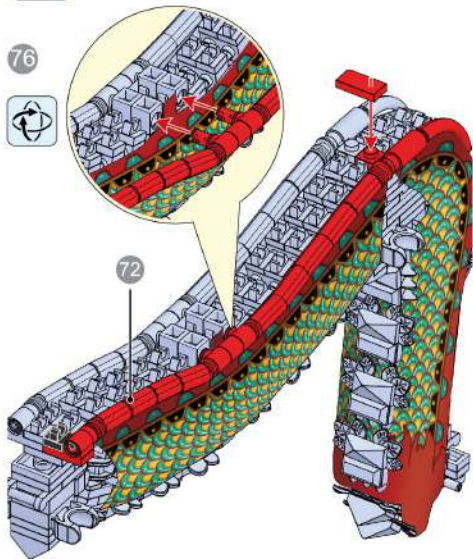

=51=

x17

x2

x1

x2

x2

x2

77

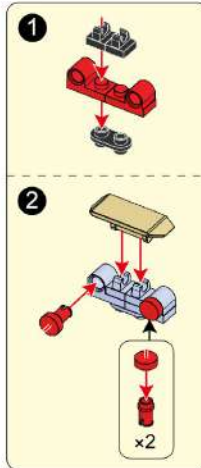

x2

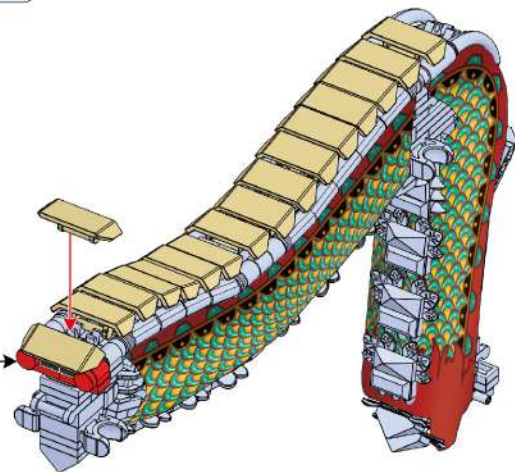

=52=



x6

78

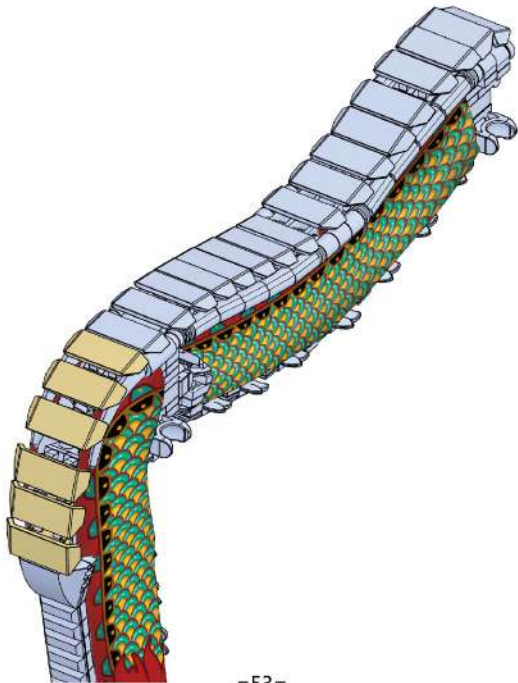

=53=

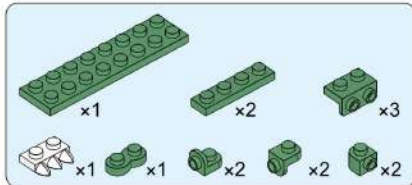

79

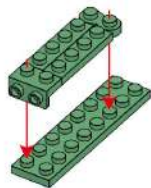

80

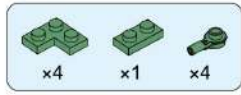
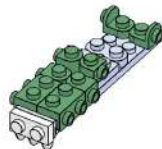

81

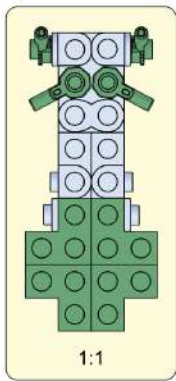
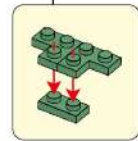

=54=

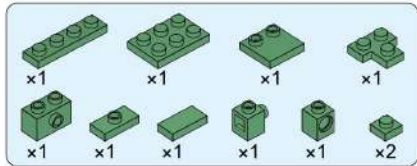

82

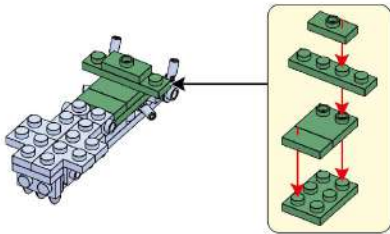

83

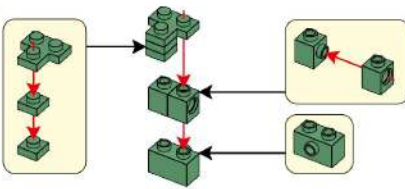

84

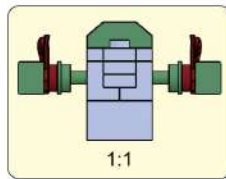
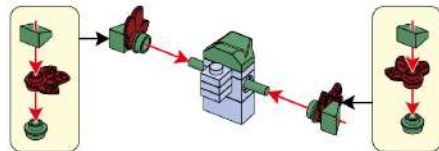

=55=

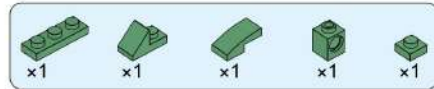

85

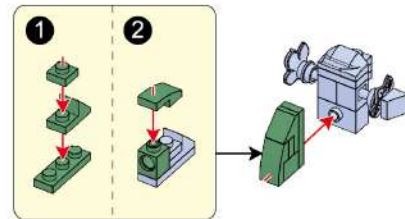

86

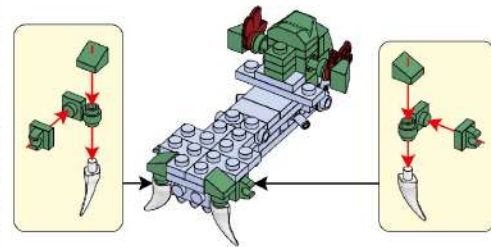

=56=

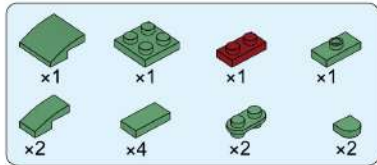

87

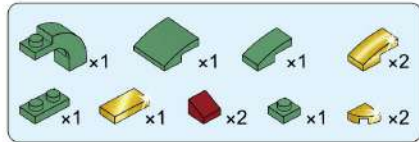
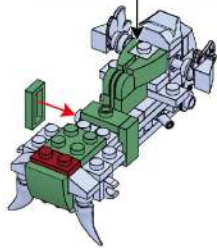
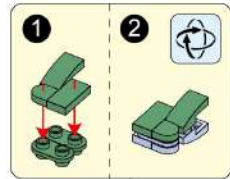

88

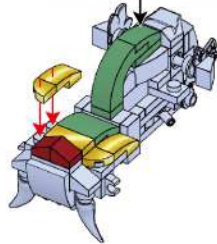
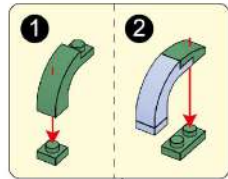

=57=

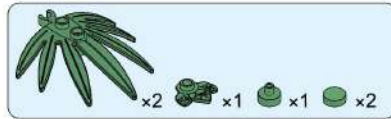

89

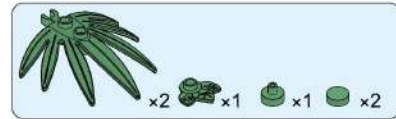
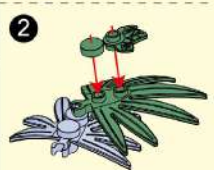
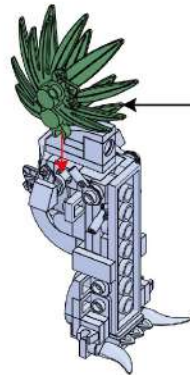

90

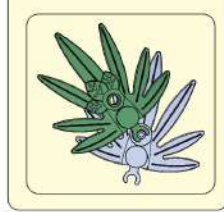
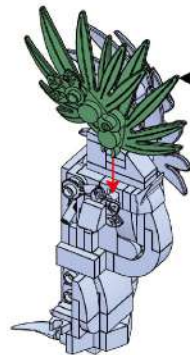

=58=

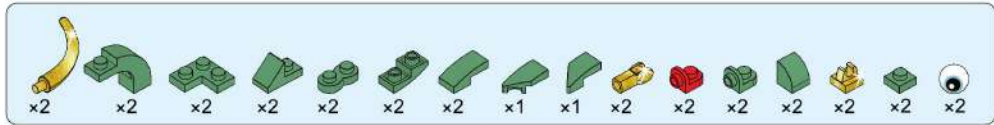

91

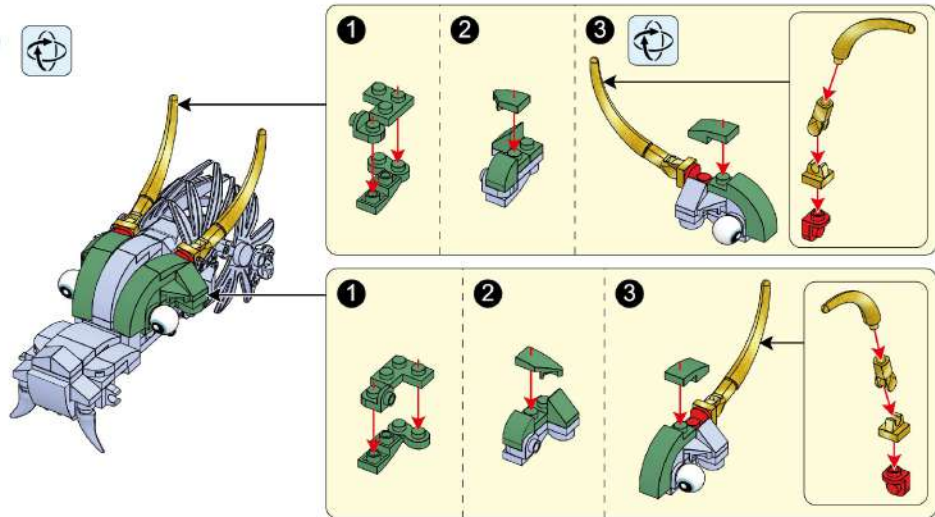

=59=

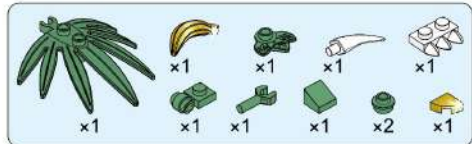

92

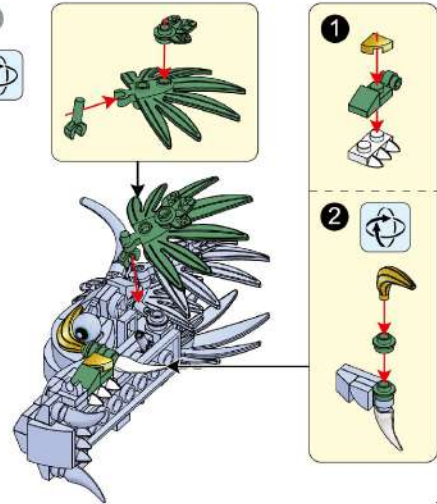

=60=

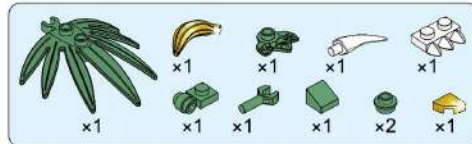

93

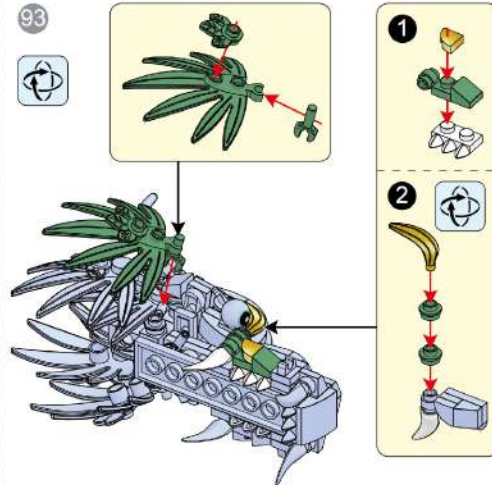

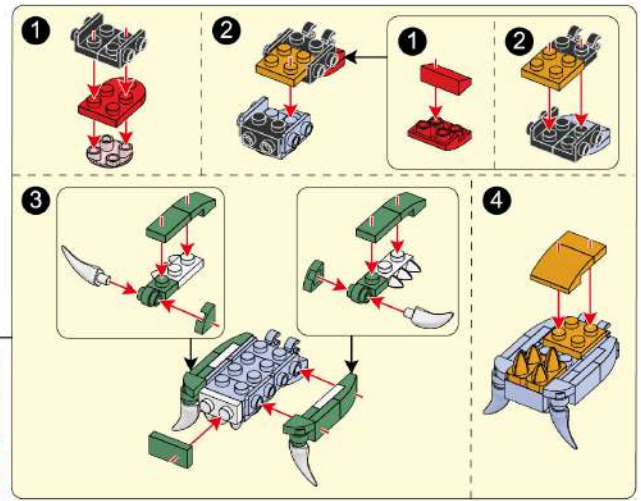
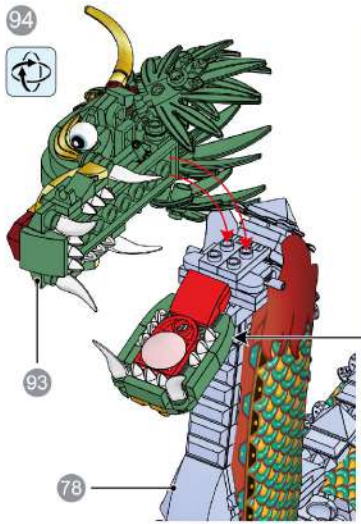
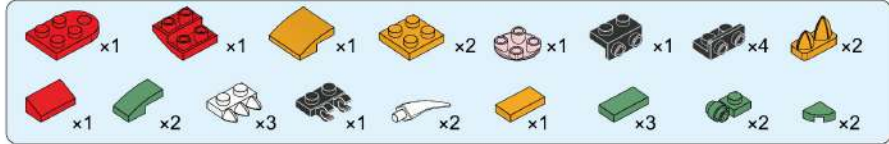

=61=

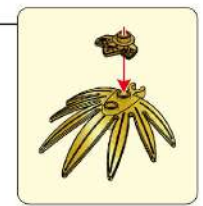
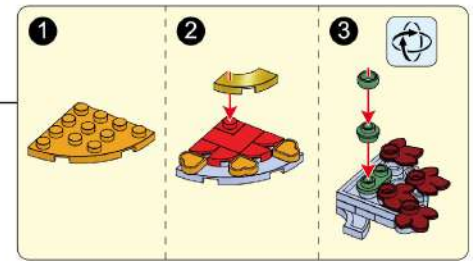
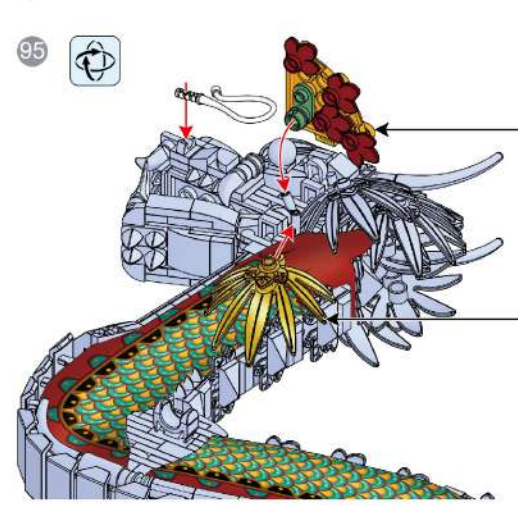
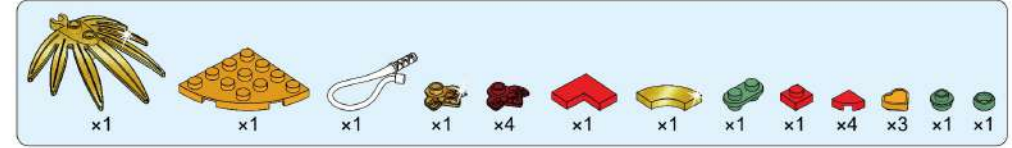

=62=

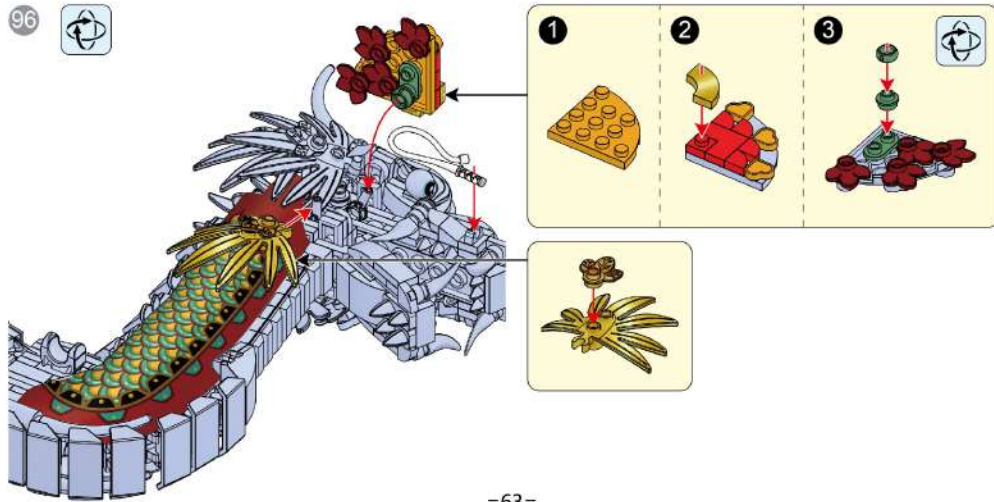

=63=

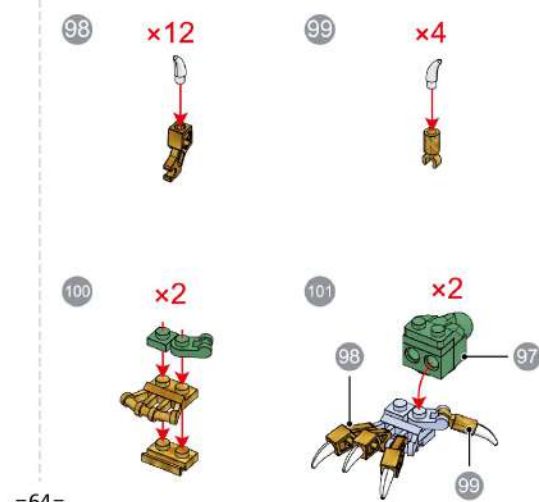
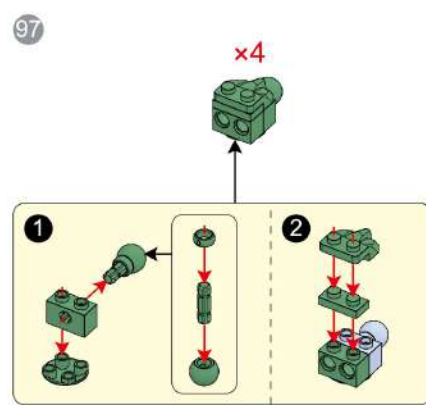
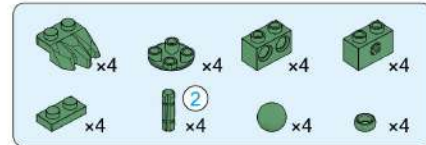

=64=



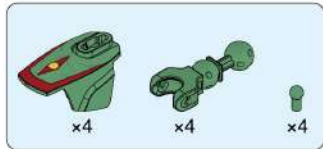

102

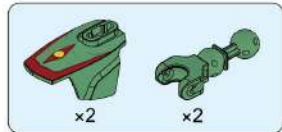

103

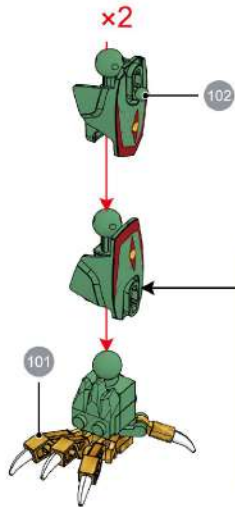

=65=

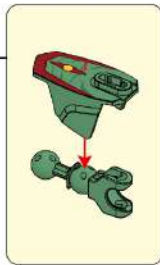

104



96

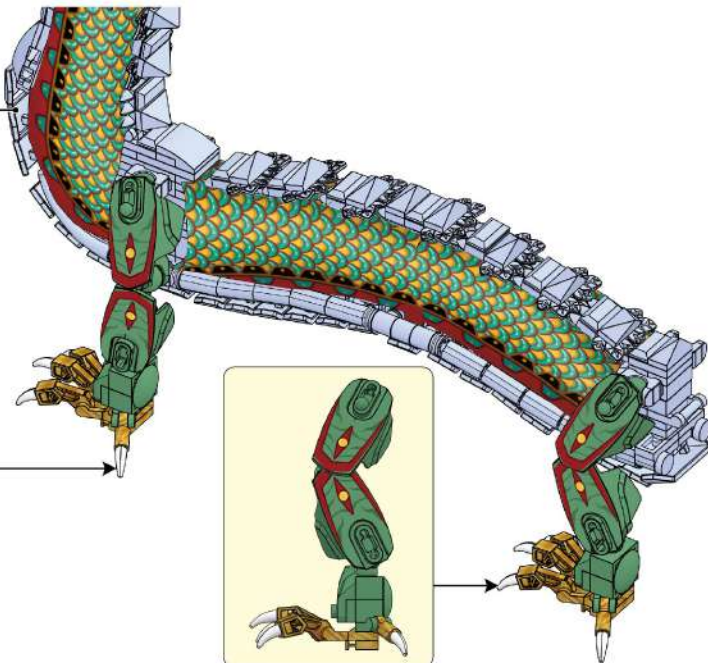
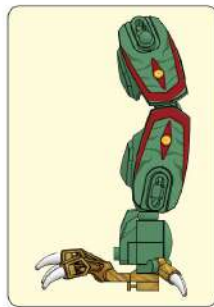

=66=



105



106

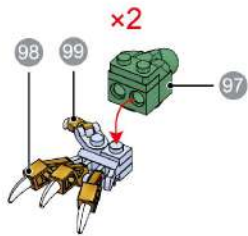

=67=

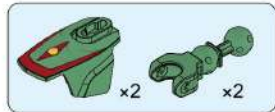

107

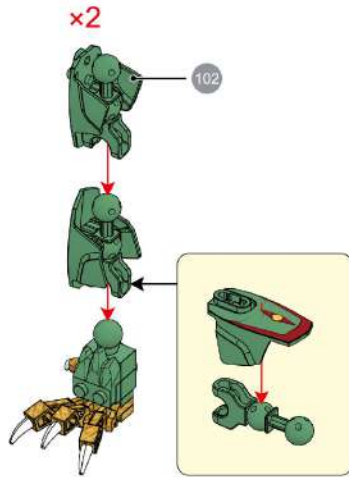

=68=

108

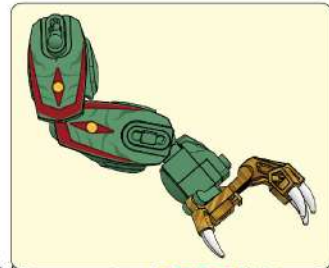
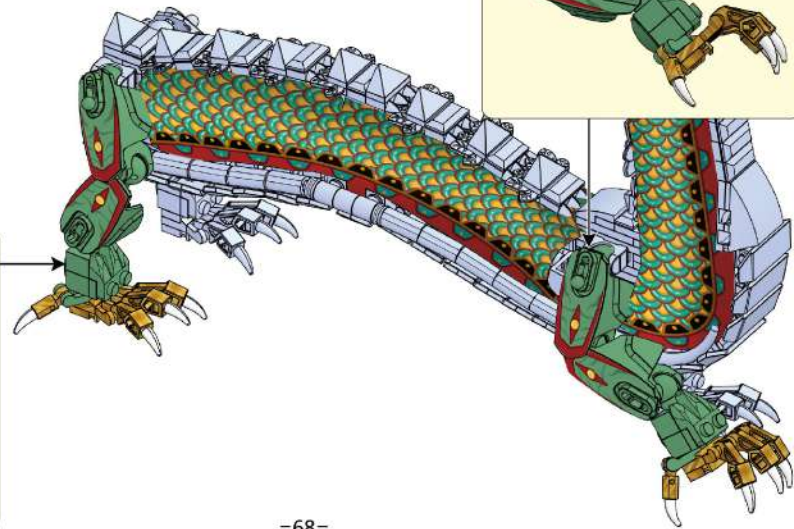
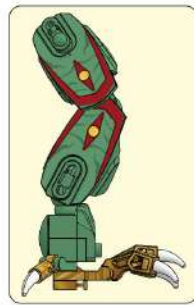

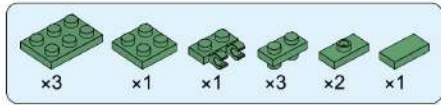

109

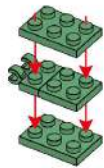

110

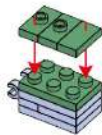

111

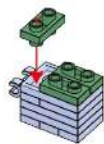

=69=

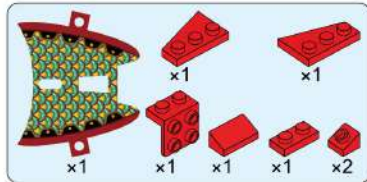

112

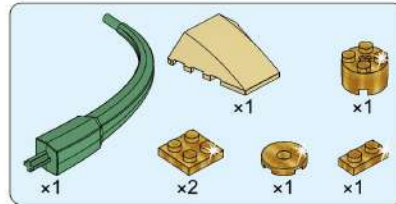
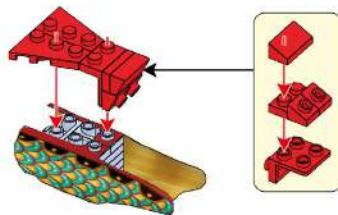

113

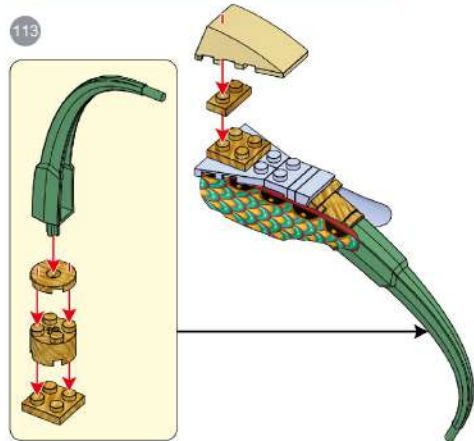

=70=



114



115

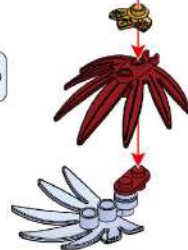

116



117

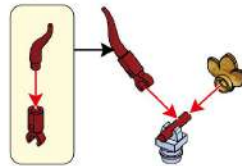

118



115

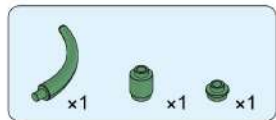

119

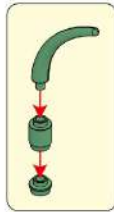

118



=71=



120



119

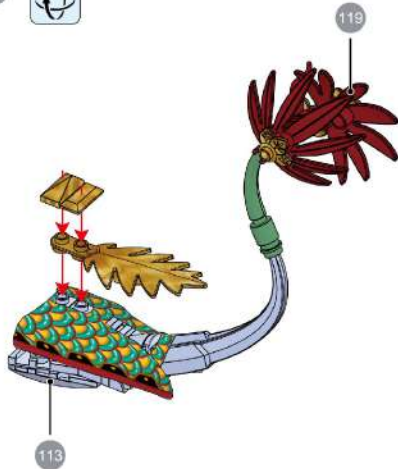

113



121

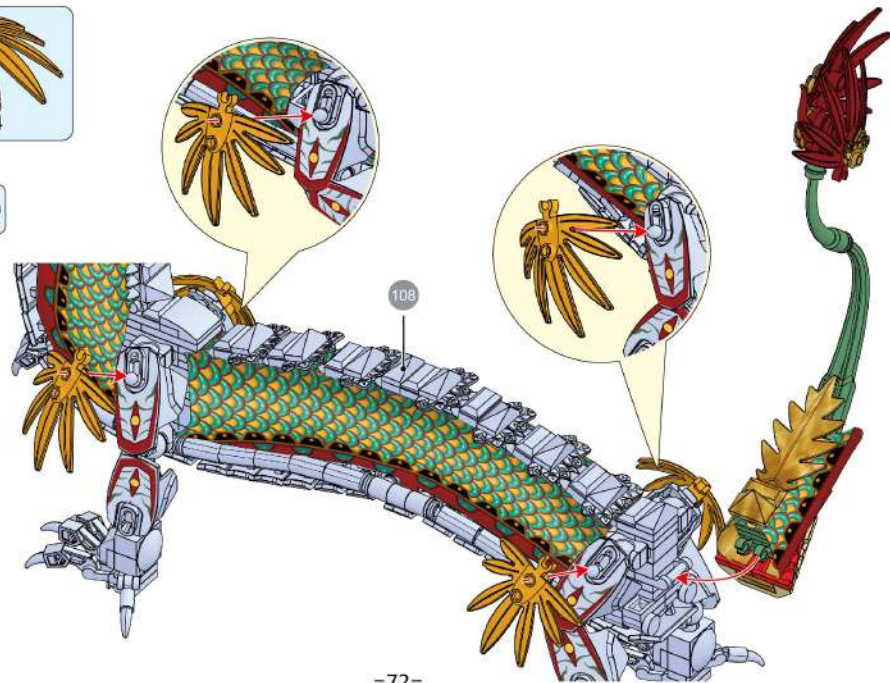

=72=

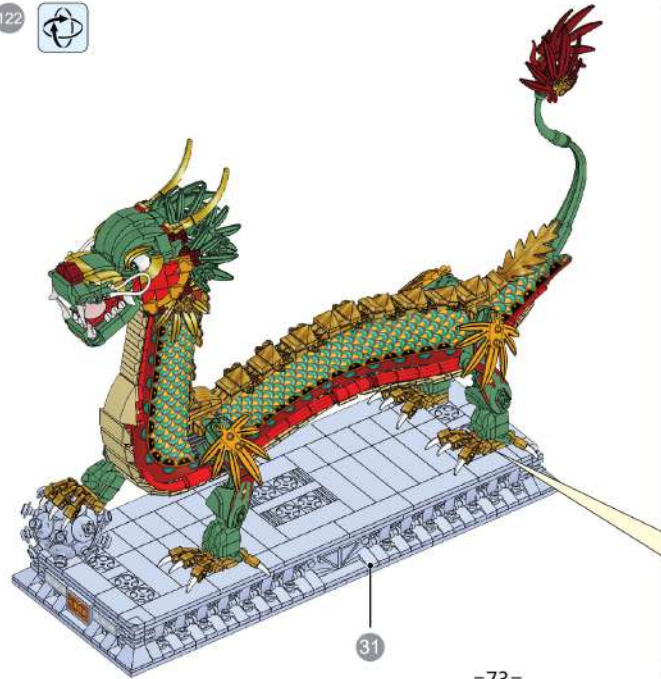

31

=73=

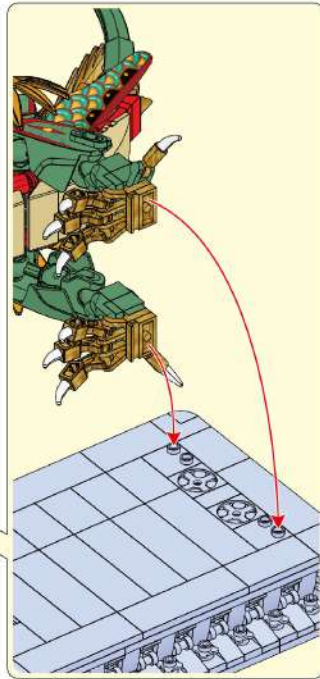

=74=





